

Ikelite Digital Housing

i n s t r u c t i o n m a n u a l

#6182.60 for Nikon Coolpix P6000

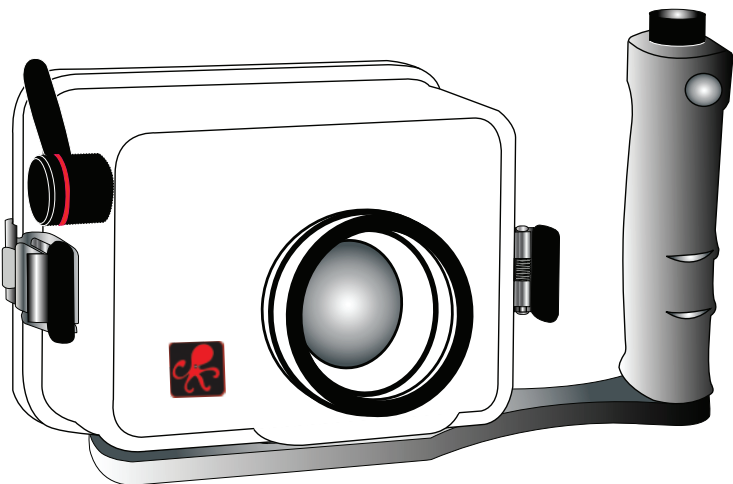

Congratulations on your purchase of an Ikelite Digital Camera Housing. Ikelite has over 45 years of experience in the underwater photographic and lighting market. Our products are designed and built in the USA by Ikelite for both the professional and amateur photographer.

The clear housing permits instant visual inspection of the camera and all sealing surfaces as well as complete monitoring of controls and camera LCD screens.

Ikelite Digital Housings are slightly negative in salt water for stability. This housing has been water pressure tested at the factory to 200' (60m).

Please Read

We suggest that you read this instruction booklet thoroughly before use. If you are new to underwater photography, be sure to read the General and Photo Tips sections.

We also suggest that you read the camera manual thoroughly to have a full understanding of where each camera control is located and what function each control provides.

Please Read If Using an EV-Controller

The EV-Controller used with Ikelite DS Substrobes has two user settings. One setting is for strobe selection, the other is for pre-flash or non pre-flash. **This camera uses pre-flash**, thus the EV-Controller should be set to the pre-flash position when used with this camera as a slave. If hard-wired to the housing, set the EV-Controller to Non pre-flash. TTL flash control is not available when using an EV-Controller, and therefore is not recommended with this housing.

Initial Camera Setup

1. Set ISO to 64 or 100.
2. Set camera to "A" Aperture priority or "M" Manual mode.
3. Set Flash to forced "On" (lightning bolt in LCD).
4. When using external strobes, set built-in flash to "Off".
5. For Macro photography, set aperture to f7.6 or 8.0.
6. Set White Balance to "Auto".
7. Set Image Quality to "Fine" and Image Size to "3:2".
8. Set Metering to "Center-Weighted".

NOTE: When using **internal flash only**, set flash control to "Auto" in the camera menu. Also make sure that the hotshoe wire allows the "pop-up" flash to open completely, otherwise the flash may not fire. Slide the hotshoe back on the camera mount until the "pop-up" flash fully extends.

2

Opening the Housing

1. Lid Snaps have a **Lock**.

To open, push Lid Snap Lock forward and lift as shown. Keep pressure on the Lid Snap so it does not fly open quickly.

Some lid snaps have a lot of spring tension once they go over center, so keep a firm grip on the lid snap. Lid Snaps may be opened one at a time.

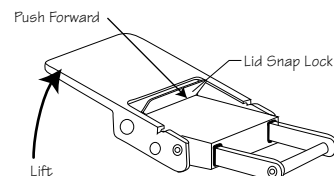

Installing the Camera

1. Pull out on each housing control until it stops. This will get the controls out of the way for installing the camera.
2. Remove the back from the housing. The mounting tray for the camera is secured to the housing back. Position the camera on the tray, and using a coin or screwdriver (preferred), secure it with the mounting bolt which threads into the camera's tripod socket.

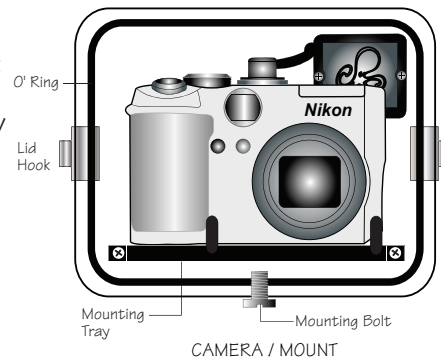

CAUTION:

Some camera tripod socket threads are plastic. The mounting tray bolt is metal. Do not cross thread or over tighten as you may damage the camera tripod socket threads.

4

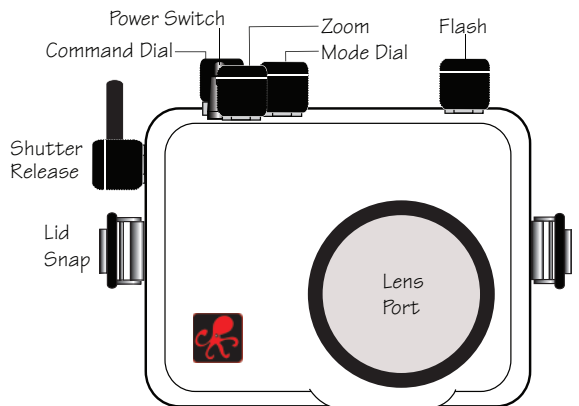

Front View

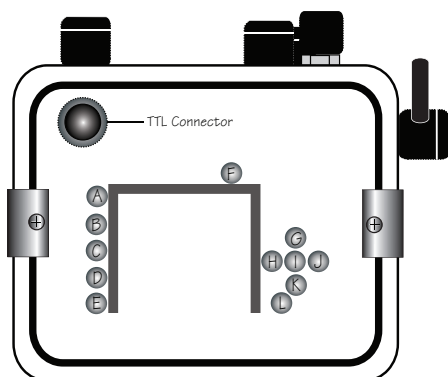

Back View

- | | | |
|------------------|----------------|---------------------------|
| [A] Fn (FUNC) | [E] Menu | [I] Apply |
| [B] My Menu | [F] Monitor | [J] Exposure Compensation |
| [C] Manual Focus | [G] Flash Mode | [K] Macro/MF (Focus Mode) |
| [D] Playback | [H] Self-timer | [L] Delete |

3

Flash Connection for External Strobes

When using an external strobe(s), connect the housing Hotshoe Connector. Slide the connector into the camera mount from the back of the camera as shown. Slide the connector forward until it stops. This can be done after the camera is secured with the mounting bolt.

NOTE: When using **internal flash only**, set flash control to "Auto" in the camera menu. Also make sure that the hotshoe wire allows the "pop-up" flash to open completely, otherwise the flash may not fire. Slide the hotshoe back on the camera mount until the "pop-up" flash fully extends.

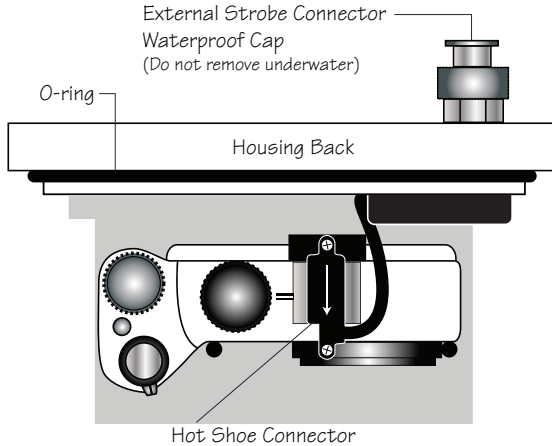

Caution:

Do not remove the External Strobe Connector's waterproof cap unless an external sync cord is going to be plugged in. Do not remove the waterproof cap or sync cord underwater.

5

Closing the Housing

1. Place housing face down in your lap or on flat surface.
2. Check to see that there is an o-ring on the housing back and that it is clean and in its proper location.
3. Guide the back into the housing front. The o-ring should touch the housing all the way around. There should be an even gap all the way around between the housing and the housing back.
4. Lift the lid snaps so they are extended and place each lid snap into the corresponding hook on the housing back.
5. To close the housing, push down on the lid snaps until they snap into place. Lid snaps on opposite sides of the housing should be closed at the same time. Be sure they are down far enough to engage the lock.

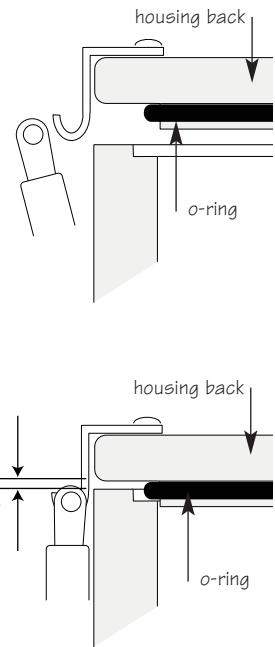

Double check - Once the housing is closed, check the o-ring seal. Check the gap between the housing back and the housing. It should be even all the way around the housing. Look through the clear plastic back at the o-ring. You should see a darkened area where the o-ring is compressed against the housing back. If you do not see an even black compression seal all the way around the back, open the lid snaps, reset the housing back and close the lid snaps. Visually check the seal again.

6

Checking Controls

Once the housing has been closed, make sure the housing controls line up with the corresponding camera controls. If the housing controls are misaligned slightly, make sure the camera hold down bolt has been tightened down firmly so the camera is flat against the tray.

Turn Camera On

Turn the camera on and operate each of the housing controls to get a feel for using the camera in the housing. Take a few pictures above water with the camera in the housing.

Zoom Control

(NOTE:) After you have used the housing's zoom control, it must be returned to the center position to disengage. If the housing zoom control is pushing the zoom lever in either direction, you may not be able to take a picture or access any other function because the camera is receiving a signal from the engaged zoom control.

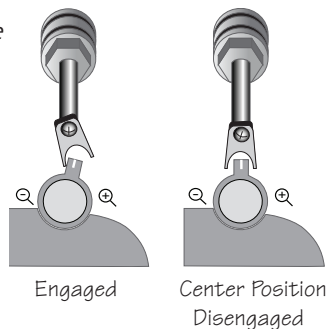

Using Flash

Using the Camera's Built-in Flash.

If you do not have an external flash, the camera's built-in flash can be used. See Diffuser instructions (Page #8 & #9).

NOTE: The camera's built-in flash cannot be used with optional Wide-Angle lenses.

7

Diffuser and Deflector Installation

Housing shown with Deflector installed.

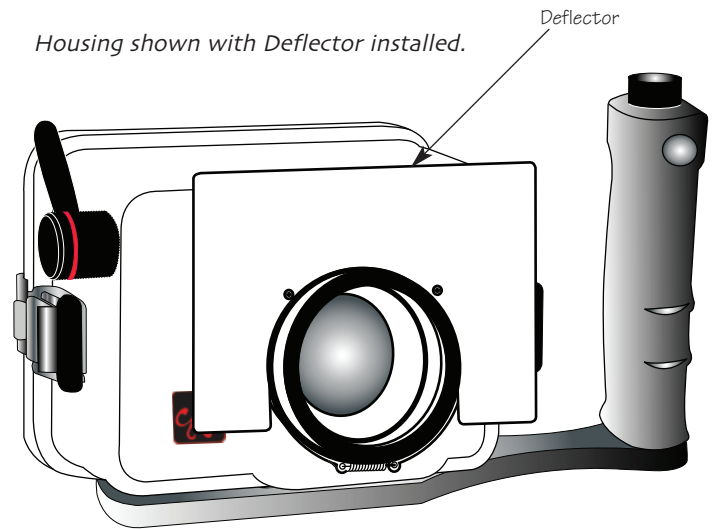

A diffuser and deflector are included with the housing. The diffuser is white transparent plastic. The deflector is also white, but is not transparent.

To install the diffuser or deflector, spread the port clamp at the spring end and slide over the lens port. The white plastic should be placed in front of the camera flash. The port clamp should be pushed back against the front of the housing.

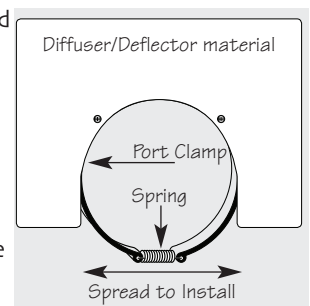

8

Diffuser

The diffuser should be installed when using the camera's built in flash. When shooting with the camera's built-in flash at approximately 2 feet (0.6 m) or less, the lens port on the housing may block a portion of the light from the camera's built-in flash, creating a shadow in the lower area of the photo. If this occurs, zoom the lens slightly to eliminate the shadow. *(You can test this above water)*

Deflector

The deflector should be installed when using an external strobe such as the DS51 or DS160 Substrobe with an EV Controller. The deflector will redirect the camera's flash to the EV Controller which controls the external strobes output. The deflector is not needed when connecting DS-digital strobes directly to the housing, since the internal camera flash will not be used.

Lens Port and Accessory Lenses

Treat the glass in the lens port as a camera lens. After use, rinse and gently dry the lens port to avoid water spotting. To clean, use a mild soap solution or lens cleaner. *Do not use alcohol or window cleaner on the Lens Port.*

The Housing Lens Port is threaded so that 67mm accessory lenses can be screwed into the end of the port. The port threads are very fine, so be carefully not to cross thread accessory lenses. These lenses can be screwed onto the lens port above or below water. These lenses are designed to have water between the front of the port and the accessory lens. Make sure no air bubbles are trapped between the port and the accessory lens. There may be slight vignetting when wide angle lenses are installed.

9

Accessory Lenses (cont.)

Any vignetting that occurs can be eliminated by cropping the image in post-processing (preferred), or by zooming the camera lens slightly. Zooming the lens with a Wide Angle Adaptor attached can cause the image edges to soften. The camera's built-in flash cannot be used with wide angle accessory lenses. The front of the lenses are so large they block the camera's flash. To properly light subjects when using a wide angle lens, an external strobe should be used. Due to the wide-angle coverage of these lenses, the DS160 Substrobe or two DS51 Substrobes are recommended. Ikelite offers **#6420 W-20** Wide-Angle accessory lens for use with this housing.

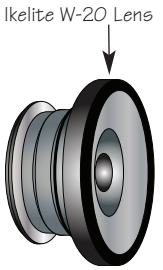

Bayonet mount adaptor lenses and internal accessory lenses which mount directly to the camera lens cannot be used with this housing.

Using External Strobes

This housing has Conversion Circuitry built into the housing back, which provides real Nikon iTTL flash when used with an Ikelite DS Digital substrobe(s), and the #4103.51 single or #4103.52 dual sync cord. *See page 11 for DS Substrobe compatibility with the Conversion Circuitry.*

Using Non-Ikelite or Ikelite Non-DS Substrobes (Substrobe 50, 100A, 200, 400) with this Housing.

The Conversion Circuitry is automatically disabled when used with a Non-Ikelite or Non-DS Substrobe. These Substrobes can be used in their manual mode utilizing any power settings provided on the Substrobe.

10

NOTE: DS Substrobe Update information

DS50 Substrobes

- DS50 SubStrobes with a Serial Number below 63,850 can not be updated to operate with the Conversion Circuitry.
- DS50 SubStrobes with a Serial Number between 63,850 and 69,999 operate with the Conversion Circuitry, but require an update to provide optimum performance.
- DS50 Substrobes with a Serial Number of 70,000 or higher, or with one of the two following labels in the battery compartment provide optimum performance with the Conversion Circuitry and do not need an update.



DS125 Substrobes

- DS125 Substrobes with a Serial Number below 2,500 must be updated to operate correctly with the Conversion Circuitry.
- DS125 Substrobes with a Serial Number between 2,501 and 4,900 will operate with the Conversion Circuitry, but require an update to provide optimum performance.
- DS125 Substrobes with a Serial Number of 5,000 or higher, or with one of the two following labels in the battery compartment, provide optimum performance with the Conversion Circuitry and do not need an update.



To Update Your Substrobe:

Send to the Ikelite address on the back page of this manual or contact Ikelite for more information.

11

Optional Accessories

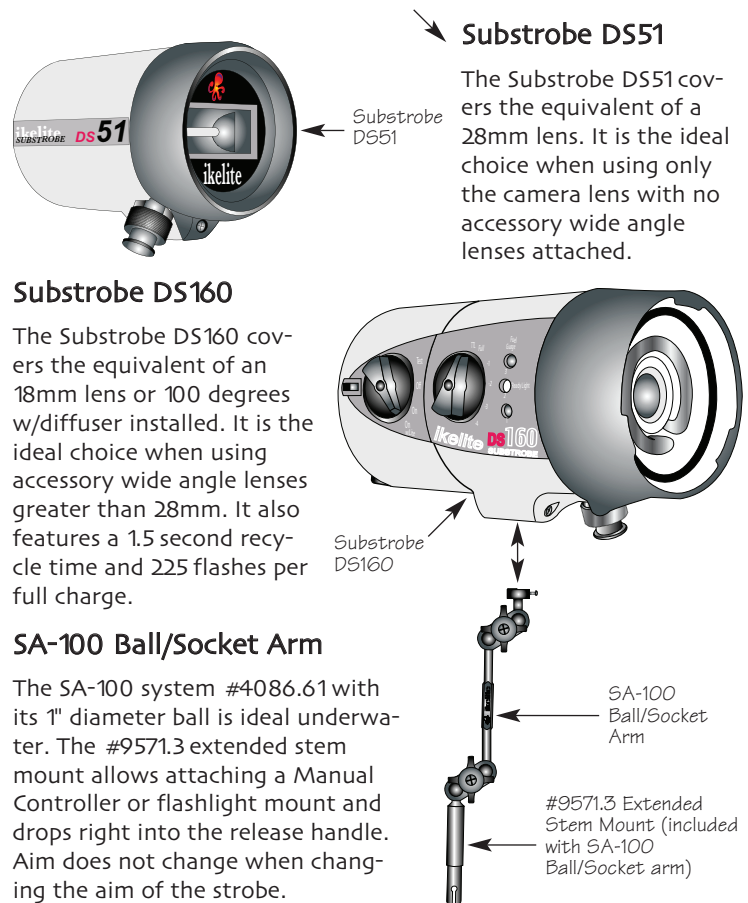

12

Optional Accessories

Back o-ring #0110

O-rings last for several years if properly maintained. (See maintenance section). Always carry a spare o-ring in case the original becomes damaged or lost.

UR/Pro Filter (Blue Water) #6441.41

The UR/Pro underwater color correcting filter is designed to restore some of the warm colors filtered out by the water. For available light use only and not recommended for use with flash.

Green Water Filter #6441.81

Enhances contrast and alters the color of green water to give our subject a rich, natural tone. For available light only and not recommended for use with flash.

Tray with Dual Release Handles #9523.32

Dual Tray and Release Handles are required to mount two external Substrobes.

Complete information regarding optional accessories available at www.ikelite.com

13

Lubricants

1. Ikelite provides silicone lubricant with the housing. We recommend you use only Ikelite lubricant on Ikelite products as some other brands may cause the o-ring to swell and not seal properly.
2. Use only enough lubricant to lightly cover control shafts and o-rings. Wipe off any excess lubricant with a clean cloth. Lubricant is not a sealant, it is used to reduce friction. Excessive lubricant can collect sand and dirt which may interfere with proper sealing.

CAUTION

Never use spray lubricants as the propellant ingredient can cause the plastic housing to crack.

Control Maintenance

Ikelite controls are designed to provide years of reliable service with minimal maintenance.

1. Push button controls require no maintenance other than rinsing in fresh water after saltwater use. If a push button control becomes difficult to push or if it sticks when depressed, soak the housing in luke warm fresh water. After a few minutes, operate the push button. If this does not correct the problem, return the housing to Ikelite for maintenance.
2. Some of the controls have long shafts. These controls can be pulled out, exposing the shaft (see diagrams A and B on pages #16 & #17). To lubricate the control, gently pull on the knob until the stainless steel shaft is exposed. Lightly lubricate the shaft, then move the shaft in and out several times. This will lubricate the x-ring in the Ikelite control gland. This should be done before using the housing after a prolonged storage period, or once a week when the housing is in constant use.

15

Maintenance

The Ikelite Digital Housing should be given the same care and attention as your other photographic equipment. In addition to normal maintenance, we recommend that the housing be returned to Ikelite periodically to be checked and pressure tested.

1. **Do Not** leave the camera and housing in direct sunlight for prolonged periods. Heat may damage the camera.
2. **Do Not** ship the camera in the housing.
3. Before using the housing, always check the tightness of the **set screw** in each control knob. Check each **control gland** penetrating the housing to make sure they are tight. There is a slight chance that either could vibrate loose during travel.
4. Keep the back o-ring clean and lightly lubricated. To lubricate, remove the o-ring from the back. Put a small amount of Ikelite lubricant on your fingers. Pull the o-ring through your fingers to apply a light coating of lubricant. Only apply enough lubricant to make the o-ring feel slick. **Do Not stretch the o-ring**. This light coating of lubricant will help to keep the o-ring from drying out and will help to show a dark sealing line when the housing back is properly sealed.
5. Keep the area where the o-ring fits and the sealing surface of the housing clean.
6. Rinse the housing exterior thoroughly in fresh water after each salt water use. Dry with a soft cloth. Dry lens port to eliminate water spotting. After several uses in salt water, soak the housing exterior in a mild soap solution, rinse and dry, before storing. When storing the housing, remove the back o-ring, lightly lubricate, and place in a plastic bag. Place the plastic bag with o-ring inside the housing for safe keeping.
7. If removing a housing push button, **Do Not** re-use the E-clip. Contact Ikelite for replacement E-clips (part #0319.12).

14

Control Maintenance Cont.

3. Some of the controls have a short shaft and cannot be pulled out exposing the shaft for lubrication. In the unlikely event one of these controls sticks or becomes difficult to operate you can remove the control from the housing and lubricate it, or return the housing to Ikelite for maintenance. To remove the control (Diagram A), loosen the set screw in the knob (allen wrench required); remove the knob. If there is salt or dirt build-up on the exposed control shaft, clean the shaft. Open the housing and gently slide the control shaft out of the control gland. Clean and lightly lubricate the shaft, including the end of the shaft. Slide the shaft back into the control gland and gently slide it back and forth a few times without fully removing the shaft from the gland. Replace the knob noting the flat area on the shaft. The set screw in the knob should tighten down against the flat area on the control, so the knob does not turn on the shaft.

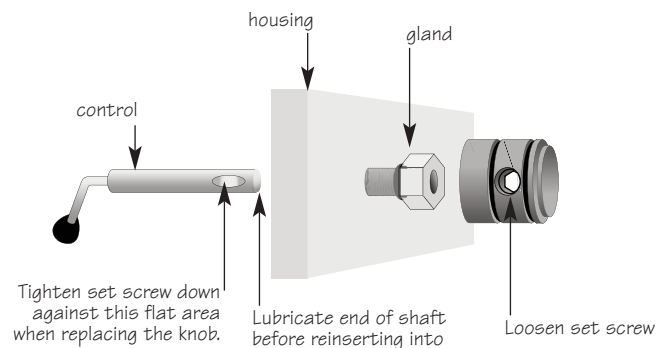
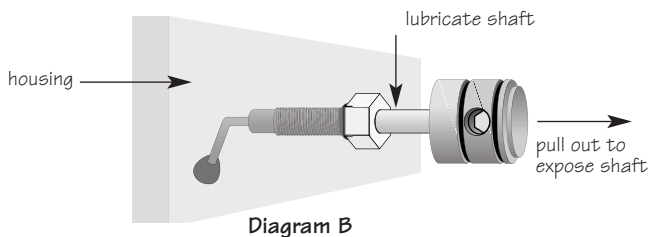

Diagram A

16



General Tips

1. Due to the power required to operate the camera, flash, and LCD screen, it is a good idea to start each dive with a fresh set of batteries.
2. Some cameras reset their flash to AUTO when the camera is turned on. If you prefer another setting be sure to select it.
3. As soon as you enter the water, take a moment and check the housing to see that it is properly sealed.
4. Next, check to see if there are any bubbles on the face of the lens port. If there are, take your finger and remove them. If there are bubbles on the lens port they can produce soft focus spots in your photographs.
5. If you are shooting with the camera's built-in flash and the camera lens is set to the widest angle, you may need to zoom the lens slightly or a shadow may appear in the lower left corner of close-up photographs. The lens port may block some of the light. Installing the flash diffuser will help to eliminate the shadow. *(You can test this above water)*

NOTE: To shoot photographs closer than 2 feet (0.6m), you should use an external strobe such as the DS51 or DS160. With an external strobe, you can position it so nothing blocks the light path between the strobe and the subject.

17

Photo Tips Cont.

6. When using daylight or flash, if your camera consistently over or underexposes the image, you may want to adjust your camera's exposure compensation settings. Many cameras allow you to adjust both available light and flash exposure with an EV control in the camera's menu.
7. Many photographers transfer their images to the computer where they can fine tune the appearance of the image. Many of the image manipulation programs make you think you can magically correct any image taken and make a good picture. One thing to remember when using an image manipulation program, is that if the image is overexposed, much of the color is missing. If the color is missing you cannot adjust it. If images are slightly underexposed, the color is there, but it is just dark and you can adjust it to some degree. So if you error in exposure, it is better to have the image slightly underexposed rather than over exposed.

19

Photo Tips

1. The number one rule in underwater photography is eliminate as much water between camera and subject as possible. Get as close as you can to the subject, then use the zoom. If you are using flash, subjects beyond 6 feet (1.8m) will not have much color.
2. The camera's built-in flash is very close to the camera lens. The flash can light up any suspended particles in the water and they can be recorded in your picture. This effect is called backscatter. To eliminate as much backscatter as possible, photograph close. Photograph in clear water; do not stir up the sand or silty bottom. If backscatter becomes a problem in the environment you are photographing, an external flash will help eliminate much of the backscatter.
3. Many digital cameras have a slight lag time between when you press the shutter release button and the camera actually takes the picture. Hold the camera steady a second or two after pressing the shutter release button.
4. Do not shoot down on subjects as they will quite often blend into the background and be difficult to see in the photograph. Shoot subjects straight on or shoot up at a slight angle using the blue water as a contrasting background.
5. Underwater flash is used to restore the warmer colors filtered out by the water as well as to illuminate the subject. When photographing underwater, set the camera to use flash on every shot. If the camera's flash is set to AUTO and the sun is behind your subject, the camera may see enough light and not fire the flash. With the sun behind the subject, the subject is shaded (dark) and needs flash for a good exposure.

18

Ikelite Limited Warranty

All Ikelite products are warranted against any manufacturing defects for a period of one year from the date of purchase. Defective products should be returned prepaid to Ikelite. Ikelite will, at its discretion, repair or replace such products, and will return to customer prepaid. All other claims, of any nature, including but not limited to bulb failure are not covered. Except as mentioned above, no other warranty expressed or implied applies to this Ikelite product.

Returning Products for Service

Ikelite is most interested in performing any service to assure that all products perform as intended. For repair or service, return the product to the address below with your name, address, phone number, and a brief description of the problem. Evidence of purchase date must be provided to obtain warranty service. Normal service turnaround time is approximately 2-3 weeks.

Ikelite Underwater Systems
50 W 33rd Street
Indianapolis, IN 46208 USA

When returning products send "attn. Repair Dept."

317-923-4523

"general questions" e-mail: ikelite@ikelite.com
www.ikelite.com

Digital 6182.60-01-1108