

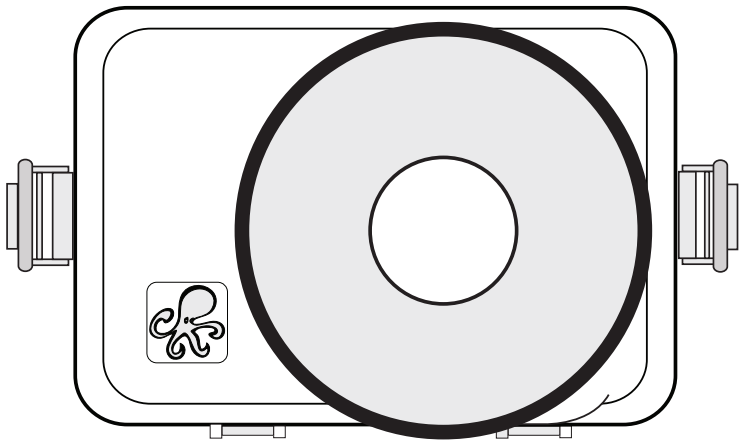

Digital Housing instruction manual

6184.82 for Nikon S8200



Thank you for your purchase of Ikelite equipment. Please read this instruction manual completely before attempting to operate or dive with this product.

Table of Contents

Product Registration	P. 3
Package Contents	P. 3
Preparation	P. 3
Initial Camera Setup	P. 4
Housing Controls - Front View	P. 5
Housing Controls - Back View	P. 6
Opening the Housing	P. 7
Installing the Camera	P. 7
Closing the Housing	P. 8
Usage	P. 9
Turn Camera On.....	P. 9
Zoom Control	P. 9
Using the Camera's Built-in Flash	P. 9
Diffuser and Deflector Use	P. 10
Entering the Water	P. 11
Maintenance	P. 11
Lens Port	P. 11
Lubricant.....	P. 11
Housing Maintenance.....	P. 12
Control Maintenance	P. 13
Specifications	P. 15
Photo Tips	P. 15
Troubleshooting	P. 17
Replacement Parts	P. 19
Recommended Accessories	P. 19
Technical Support	P. 21
Limited Warranty	P. 22
Returning Products for Service	P. 23

Product Registration

Please take a moment to fill out the online **Ikelite Product Registration** form at <http://www.ikelite.com/forms/regForm.htm>.

Package Contents

- Ikelite Digital Housing
- Housing Lanyard (attached)
- Silicone Lubricant
- Vinyl Port Cover
- Diffuser
- Deflector
- Extra Control Tips



Preparation

This product has been water pressure tested at the factory and is depth rated to 200 ft. (60m). Thoroughly inspect and immerse the empty housing completely in water before installing a camera. If any fogging occurs or droplets of water enter the housing, do not install a camera. Clean the housing main o-ring and retest to make sure that it is watertight. Refer to the Troubleshooting section, page 17.

We suggest that you read this instruction booklet thoroughly before use to have a full understanding of where each camera control is located, and what function each control provides. Please read your camera manual thoroughly to have a full understanding of each camera function. If you are new to underwater photography, be sure to read the Photo Tips section.

Due to the power required to operate the camera and LCD screen start each dive with a fully charged camera battery.

Initial Camera Setup (before placing camera in housing)

- Insert a fully charged battery.
- Insert and format a memory card.
- Set camera Time Zone and Date.
- Set AF-assist beam to “Off.”
- Set camera to “Auto mode .
- Set Flash Mode to “Fill flash .
- Set White Balance to “Auto.”
- Set Image Mode to “14m.”
- Set Metering to “Center-weighted.”
- Set ISO to “100.”
- Set AF area mode to “Center.”
- Set Autofocus mode to AF-S “Single AF.”
- Set Vibration reduction to “On.”
- Set Auto off to “5 min.”
 - Set Macro mode  to “On” when shooting close-up. If the image is overexposed, back away, zoom in, and then reshoot.

Housing Controls - Front View

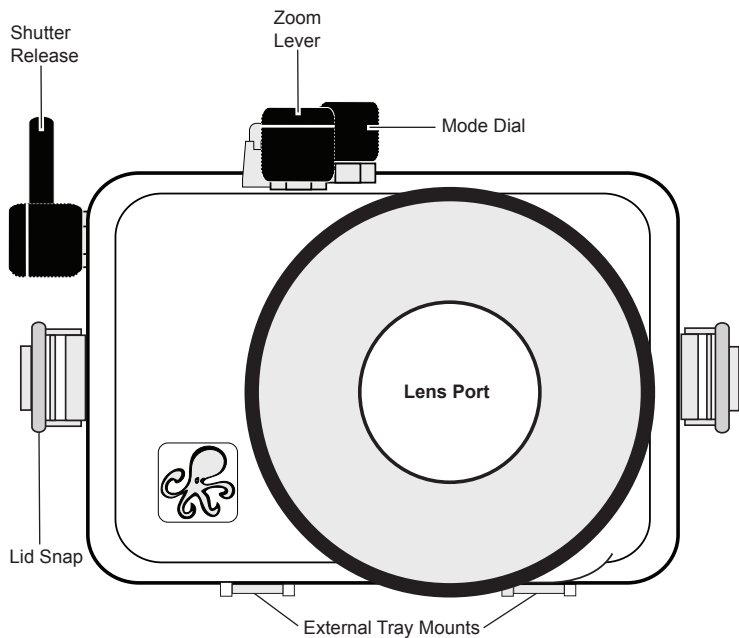

Housing Controls - Back View

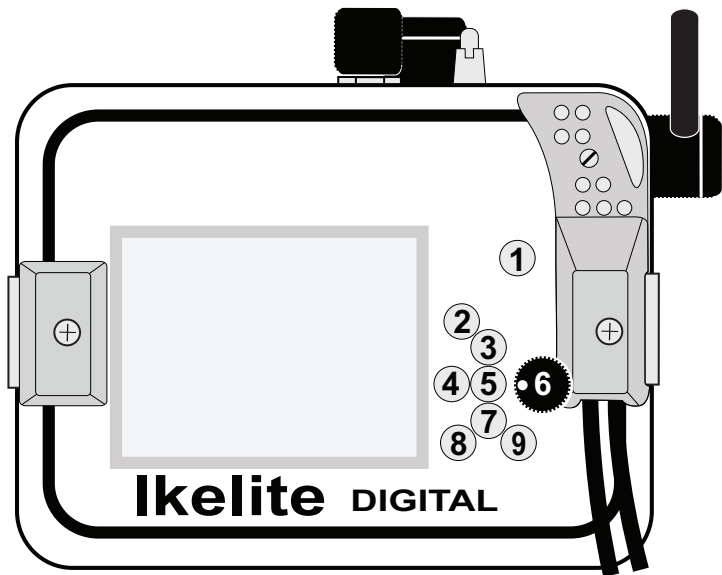

Housing Controls

1. Movie Record Button

2. Playback Button 

3. Flash Mode , 

4. Self-timer, 

5. OK, Apply Selection 

6. Rotary Selector, , 

7. Macro Mode , 

8. Menu Button

9. Delete Button 

Opening the Housing

Lid Snaps have a **Lock**.

To open housing, push Lid Snap Lock forward and lift as shown.

Keep pressure on the Lid Snap so it does not fly open quickly.

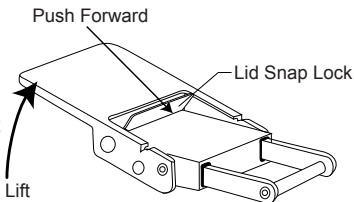

Some Lid Snaps have a lot of spring tension once they go over center, so keep a firm grip on the Lid Snap.

Lid Snaps may be opened one at a time.

Installing the Camera

1. Pull out on each housing control until it stops. This will get the controls out of the way for installation of the camera.
2. Remove the back from the housing.
3. The mounting tray for the camera is secured to the housing back. Position the camera on the tray.
4. Using a coin or screwdriver (preferred), secure the camera with the tray mounting bolt which threads into the camera's tripod socket - Diagram A.

CAUTION:

Some camera tripod socket threads are plastic. The mounting bolt is metal. Do not cross thread or over tighten as you may damage the camera tripod socket threads.

Diagram A

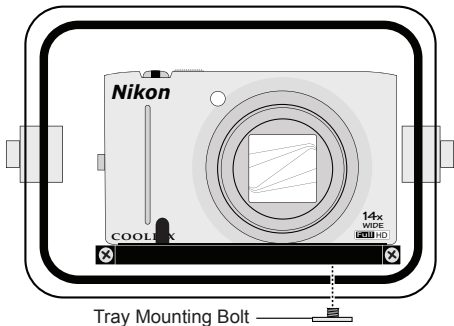

Closing the Housing

1. Place housing face down in your lap or on flat surface.
2. Check to see that there is an o-ring on the housing back and that it is clean and in its proper location.
3. Guide the back into the housing front. The o-ring should touch the housing all the way around. There should be an even gap all the way around between the housing and the housing back.
4. Lift the lid snaps so they are extended and place each lid snap into the corresponding hook on the housing back.
5. To close the housing, push down on the lid snaps until they snap into place. Lid snaps on opposite sides of the housing should be closed at the same time. Be sure they are down far enough to engage the lock.

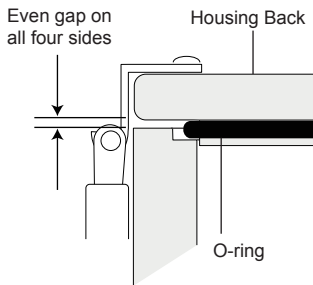
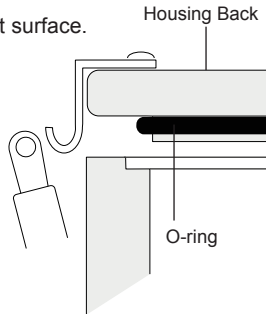

Double check - Once the housing is closed, check the o-ring seal. Check the gap between the housing back and the housing. It should be even all the way around the housing. Look through the clear plastic back at the o-ring. You should see a darkened area where the o-ring is compressed against the housing back. If you do not see an even black compression seal all the way around the back, open the lid snaps, reset the housing back and close the lid snaps. Visually check the seal again.

Usage

Turn Camera On

Turn the camera on and operate each of the housing controls to get a feel for using the camera in the housing.

You are now ready to shoot underwater photos!

Zoom Control (lever type only)

After you have used the housing's zoom control, it must be returned to the center position to disengage. If the housing zoom control is pushing the zoom lever in either direction, you may not be able to take a picture or access other functions. This is because the camera is receiving a signal from the engaged zoom control.



Zoom Control
"Disengaged"
(Center Position)



Zoom Control
"Engaged"

Using the Camera's Built-in Flash

If you are shooting with the camera's built-in flash and the camera lens is set to the widest angle setting, you may need to zoom the lens slightly or a dark area may appear in a lower corner of close-up photographs.

The lens port may block some of the light. Install the Diffuser and zoom in to eliminate any dark areas noted in your photographs (*You can test this above water*). See Diffuser/Deflector Installation - page 10.

For the best results, we recommend using an external Ikelite Substrobe.

The camera's built-in flash CANNOT be used with optional Wide Angle or Accessory lenses.

Note: To shoot photographs closer than 2 feet (0.6m), we recommend using an external strobe which can be positioned so nothing blocks the light path between the strobe and the subject.

Diffuser and Deflector Installation

A diffuser and deflector are included with the housing. The diffuser is white transparent plastic. The deflector is also white but is not transparent.

To install the diffuser or deflector, push the “Cut-out” Section into the port groove until it stops.

Note the Small Hole. To avoid losing the diffuser or deflector, you can attach a fishing line or string to this hole.

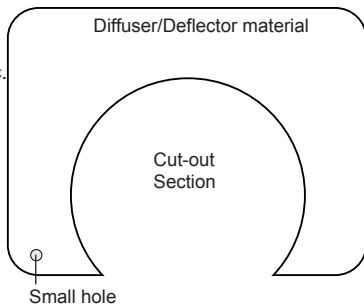

Diffuser/Deflector properly installed in port groove

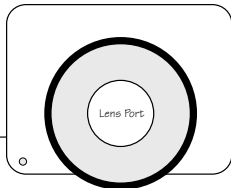

Diffuser Use

The diffuser should be installed when using the camera flash. When shooting close-up photographs with the camera flash and at the camera lens's widest angle setting, the lens port on the housing can block a portion of the light from the camera flash. This can result in a shadow in a lower corner of the frame. Zoom the lens to eliminate the shadow (*You can test this above water*).

Deflector Use

The deflector should be installed when using an Ikelite external strobe. The deflector will block and redirect the camera's flash to the AF35 slave unit or EV-controller which controls the external strobe's output. Remove the diffuser before attempting to install the deflector.

Entering the Water

As soon as you enter the water, take a moment and check the housing to see that it is properly sealed.

Next, check to see if there are any bubbles on the face of the lens port. If there are, take your finger and remove them. If there are bubbles on the lens port they can produce soft focus spots in your photos or video.

Maintenance

Lens Port

Treat the glass or acrylic in the lens port as a camera lens. After use, rinse and gently dry the outside lens port to avoid water spotting. To clean, use a mild soap solution or lens cleaner. Do not rinse the inside port glass. **Do not use alcohol or window cleaner on the Lens Port.**

Lubricant

- Ikelite provides silicone lubricant with the housing. We recommend you use **only** Ikelite lubricant on Ikelite products. Other brands may cause the main housing o-ring to swell and not seal properly.
- Use only enough lubricant to lightly cover the main housing o-ring or lubricate a sticky control. Wipe off any excess lubricant with a clean cloth. Lubricant is not a sealant, it is used to reduce friction. Excessive lubricant can collect sand and dirt which may interfere with proper sealing.

CAUTION:

Never use spray lubricants as the propellant ingredient can cause the plastic housing to crack or o-rings to swell.

Housing Maintenance

The Ikelite Digital Housing should be given the same care and attention as your other photographic equipment. In addition to normal maintenance, we recommend that the housing be returned to Ikelite periodically to be checked and pressure tested.

- **Do Not** leave the camera and housing in direct sunlight for prolonged periods. Heat may damage the camera.
- **Do Not** ship the camera in the housing.
- Before using the housing, always check the tightness of the **set screw** in each control knob.

Check each **control gland** penetrating the housing to make sure they are tight. There is a slight chance that either could vibrate loose during travel.

- Keep the main housing o-ring clean and lightly lubricated. To lubricate, remove the o-ring from the back. Put a small amount of Ikelite lubricant on your fingers. Pull the o-ring through your fingers to apply a **light** coating of lubricant. Only apply enough lubricant to make the o-ring feel slick. **Do Not stretch the o-ring**. This light coating of lubricant will help to keep the o-ring from drying out and will help to show a dark sealing line when the housing back is properly sealed.
- Keep the area where the o-ring fits and the sealing surface of the housing clean.
- Rinse the housing exterior thoroughly in freshwater after each saltwater use. Dry with a soft cloth. Dry lens port to eliminate water spotting. After several uses in saltwater, soak the housing exterior in a mild soap solution, rinse and dry before storing. When storing the housing, remove the back o-ring, lightly lubricate, and place in a plastic bag. Place the plastic bag with o-ring inside the housing for safe keeping.
- If removing a housing push button, **Do Not** re-use the E-clip. Contact Ikelite for replacement E-clips (part #0319.12).
- Leave lid snaps in the open position when not using the housing for extended periods.

Control Maintenance

Ikelite controls are designed to provide years of reliable service with minimal maintenance.

- Push button controls normally require no maintenance other than rinsing in freshwater after saltwater use. If a push button control becomes difficult to push or if it sticks when depressed, soak the housing in luke warm freshwater. After a few minutes, operate the push button. If this does not correct the problem, return the housing to Ikelite for maintenance. If you are on a trip and unable to return the housing immediately, a push button may be lubricated by pressing and holding the push button all the way in. Then, use your finger or other small object to place a small amount of lube at the base of the shaft inside the housing. Press and release the push button several times until the lube is worked up into the o-ring.
- Some of the controls have long shafts. These controls can be pulled out, exposing the shaft see diagrams B and C - page 14. To lubricate the control, gently pull on the knob until the stainless steel shaft is exposed. Lightly lubricate the shaft, then move the shaft in and out several times. This will lubricate the x-ring in the Ikelite control gland. This should be done before using the housing after a prolonged storage period, or once a week when the housing is in constant use.
- Some of the controls have a short shaft and cannot be pulled out exposing the shaft for lubrication. In the unlikely event one of these controls sticks or becomes difficult to operate, you can remove the control from the housing and lubricate it, or return the housing to Ikelite for maintenance. To remove the control, diagram B - page 14, loosen the set screw in the knob (allen wrench required); remove the knob. If there is salt or dirt build-up on the exposed control shaft, clean the shaft. Open the housing and gently slide the control shaft out of the control gland. Clean and lightly lubricate the shaft, including the end of the shaft.

Control Maintenance - continued

Slide the shaft back into the control gland and gently slide it back and forth a few times without fully removing the shaft from the gland.

Replace the knob noting the flat area on the shaft. The set screw in the knob should tighten down against the flat area on the control so the knob does not turn on the shaft.

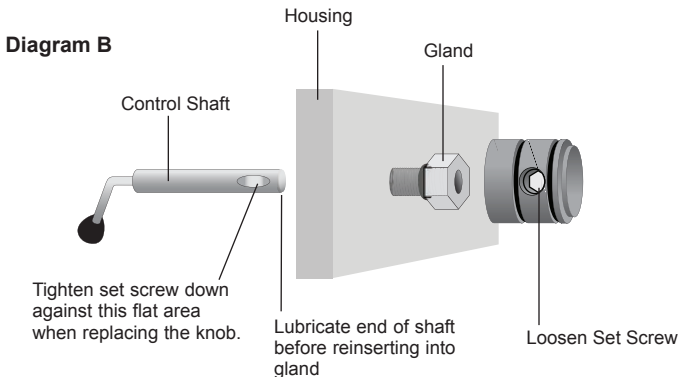
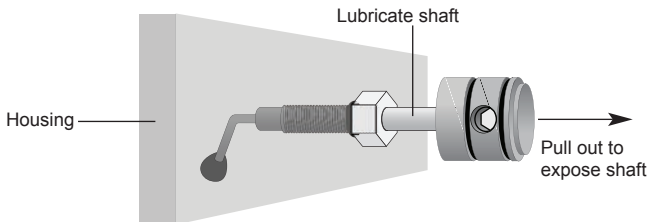

Diagram C



Specifications

Width	7 in. (180mm) including controls
Height	5 in. (130mm) including controls
Depth	5.9 in. (150mm) including controls and lens port
Weight	2.9 lb (1340g)
Buoyancy	Near neutral in freshwater

Photo Tips

- The number one rule in underwater photography is to eliminate as much water between the camera and subject as possible. Get as close as you can to the subject, then use the zoom. If you are using flash for still photos, subjects beyond 6 feet (1.8m) will not have much color regardless of strobe power.
- Photograph in clear water; do not stir up the sand or silty bottom. If backscatter becomes a problem in the environment you are photographing, an external flash will help eliminate much of the backscatter.
- Many digital cameras have a slight lag time between when you press the shutter release button and the camera actually takes the picture. Hold the camera steady a second or two after pressing the shutter release button.
- Do not shoot down on subjects as they will quite often blend into the background and be difficult to see in the photograph. Shoot subjects straight on or shoot up at a slight angle using the blue water as a contrasting background.
- When using daylight or flash, if your camera consistently over or underexposes the image, you may want to adjust your camera's exposure compensation  settings.

Photo Tips - continued

- If you error in exposure, it is better to have the image slightly underexposed rather than overexposed. An overexposed image is missing color information which cannot be adjusted in a photo processing program. A slightly underexposed image has color information that can be adjusted.
- It is important to respect all living creatures underwater, including people, marine life, and coral. While we encourage people to get close to their subjects when taking a photograph, they should not touch, lie on, or in any way disturb the things they find underwater.

Troubleshooting

Problem	Solution
Push buttons or controls are sticky and hard to operate	<ul style="list-style-type: none">- Remove the camera and rinse the closed housing in freshwater. Vigorously press each push button in and out several times to release any trapped saltwater or debris.- Press a sticky push button all the way in and place a small amount of lube on the small end of the push button shaft at it's base. Release and operate the push button several times to distribute the lube.- If a control is sticky, grab the control knob, pull it out, and then push back in. If still sticky, see the Control Maintenance section - pages 13 & 14.- Return housing to Ikelite for routine maintenance.
Image is over- or under-exposed, or a corner of the image is dark	<ul style="list-style-type: none">- Check that the camera flash is firing when taking a picture. Camera flash should be forced "on."- Make sure the deflector is installed when you are using an external strobe.- Make sure the diffuser is installed when you are NOT using an external strobe.- When using an external strobe, make sure it is turned on, set properly, and it's battery is charged.- Check any corded connection points.- Change camera shutter speed or aperture.- Move closer to or further away from the subject.

Problem	Solution
Camera does not take a picture	<ul style="list-style-type: none"> - Install a fully charged battery. - If using a “lever type” zoom control, make sure the control is centered and not engaged. - There is not enough available light for the camera to properly focus. Add a focusing light or strobe with a built-in focusing light to your system. - Select macro mode when shooting close-ups.
Housing is hard to close	<ul style="list-style-type: none"> - Make sure the camera is mounted properly on the camera tray and housing controls are out of the way . - Main housing o-ring is not seated properly.
Fogging occurs on the Lens Port	<ul style="list-style-type: none"> - Humid air is trapped inside the housing. The camera produces heat and may condense any trapped moisture forming fog on the lens port. Close the housing in an air-conditioned room or vehicle, or in front of an air-conditioner. - The housing should not be direct in sunlight for an extended period of time. - Purchase desiccant packs also known as moisture munchers from a local camera store. Place one or two packs in your housing before each day of diving. - If moisture or water droplets are present around the controls or sealing areas, return the housing to Ikelite for evaluation. - Clean the main housing o-ring and sealing surface of the housing.

Problem	Solution
Water enters the housing	<ul style="list-style-type: none"> - Remove, clean and properly lubricate the main o-ring. - Look for hair, dirt, or foreign debris crossing the o-ring seal. - Reassemble the housing without a camera installed and pressure test or take diving. - Return housing to Ikelite for routine maintenance.
Pictures are too blue or too green	<ul style="list-style-type: none"> - Use custom (manual) white balance if available. Reset for each working depth or when attaching a color correcting filter. - Add an optional color correcting filter. - Add an external strobe. - Move in closer to your subject when taking a picture.

Replacement Parts

Main Housing O-ring 0109

Lanyard 0321.10

Vinyl Port Cover 0200.08

Ikelite Lube 5020 (4 - 1cc tubes)

For light lubrication of the main housing o-ring.

Recommended Accessories

A full range of accessories is available to support your housing. Please visit http://www.ikelite.com/web_two/nik_s8200.html to see the most current information about recommended accessories.

Recommended Accessories - continued

Tray and Handle(s)

Add stability and gripping point(s) for comfortable use of the housing above and below water. Some tray and handles offset the slightly positive buoyancy of the housings. Handles offer attachment points for external lighting systems.

External Strobes

A separate external strobe adds color to restore the warmer colors filtered out by the water as well as to illuminate the subject. Add a second strobe to eliminate shadows and evenly light your subjects.

Video Lighting

External video lights add color when using the video/movie mode of your camera. Primary video lights are specially color balanced to provide natural tones.

Travel Cases

Protect your investment and travel with ease. An optional Carrying Case or Travel Bag will accommodate the housing with a single AF35 or DS51 strobe, including a single tray with handle and accessories.

External Color Correcting Filters

Color filters such as the UR-Pro Filter replace some of the reds, oranges and more natural tones that would otherwise be lost underwater. Effective in relatively shallow, sunny conditions. Available for tropical blue water and green water settings. For optimum results use in combination with “custom (manual) white balance.” Check your camera user guide for information on this option (if available). Not recommended when using external strobes.

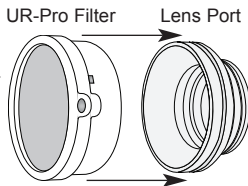

Recommended Accessories - continued

UR/Pro Filter (Blue Water)

The UR/Pro underwater color correcting filter is designed to restore some of the warm colors filtered out by the water. For available light use only. Not recommended for use with an external flash.

UR/Pro Filter (Green Water)

Enhances contrast and alters the color of green water to give your subject a rich, natural tone. For available light use only. Not recommended for use with an external flash.

Accessory Lens Information

67mm threaded accessory lenses can be attached to the front of the housing port. Vignetting will be present with a wide angle lens attached.

Please Read If Using an EV Manual Controller

The EV-Controller used with Ikelite DS Substrobes has two user settings. One setting is for strobe selection, the other is for pre-flash "P" or non pre-flash "⊗." Most cameras use a pre-flash. This means the EV-Controller should be set to the pre-flash "P" position when used with this camera as a slave. If a manual mode is used that does not emit a pre-flash, set the EV-controller to the non pre-flash "⊗" position.

Technical Support

Please read the troubleshooting section of this instruction manual before contacting technical support.

Ikelite Technical Support

Email: ikelite@ikelite.com

Phone 317.923.4523

Fax 317.924.7988

Limited Warranty

This Ikelite product is warranted against any manufacturing defects for a period of one (1) year from the original date of purchase. Defective products should be returned to Ikelite postage paid. Ikelite will, at its sole discretion, repair or replace such products, and will return to customer postage paid. All other claims of any nature are not covered. Except as mentioned above, no other warranty expressed or implied applies to this Ikelite product.

Returning Products for Service

Ikelite is most interested in performing any service to ensure that all products perform as intended. Evidence of purchase date must be provided to obtain warranty service.

No prior authorization is required. You may return directly to us or through your dealer. Please include a brief description of the problem, any relevant email correspondence, and/or instructions on what you want us to do. Always include name, shipping address, email address, and phone number inside of the package. Send postage paid to:

Ikelite Underwater Systems
Attention: Service Department
50 West 33 Street
Indianapolis, IN 46208 USA

No reimbursements for postage paid will be issued.

You may also want to insure the package.

Returning Products for Service (outside the United States)

For the separate international customs documentation form that you complete to accompany the shipment, please state or designate that the enclosed products were originally manufactured in the USA and are being returned to the manufacturer for repair service. Value of the equipment listed for customs purposes should be zero.



**Ikelite Underwater Systems
50 West 33rd Street
Indianapolis, IN 46208 USA**

www.ikelite.com