

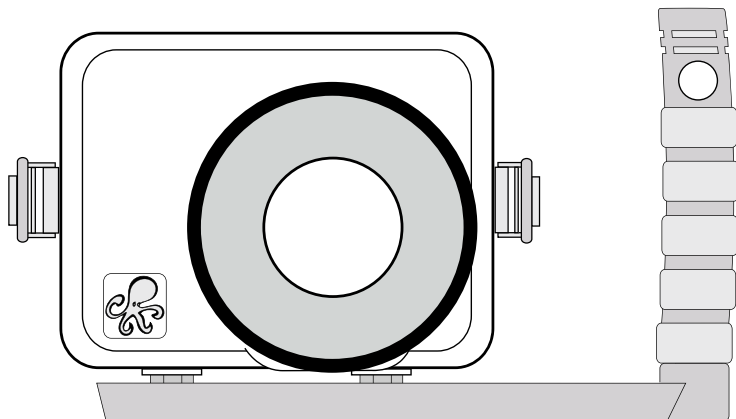

# Digital Housing #6146.12 instruction manual Canon Powershot G11, G12



## Product Registration

Please take a moment to fill out the online **Ikelite Product Registration** form at <http://www.ikelite.com/forms/regForm.htm>.

## Table of Contents

P. 1.....	Product Registration
P. 2.....	Table of Contents
P. 3.....	<b>Package Contents : Preparation</b>
P. 4.....	Initial Camera Setup
Pp. 5-6 .....	Housing Controls
Pp. 7-8 .....	Opening the Housing: Installing the Camera
P. 9.....	Closing the Housing
P. 10.....	<b>Usage</b>
	Turn Camera On
	Zoom Control
	Using the Camera's Built-in Flash
P. 11 .....	Diffuser and Deflector Installation and Use
P. 12.....	Entering the Water
Pp. 12-15 .....	<b>Maintenance</b>
	Lubricant, Housing Maintenance, Control Maintenance
Pp. 16-17 .....	<b>Specifications, Photo Tips</b>
Pp. 18-19 .....	<b>Troubleshooting</b>
Pp. 20-25 .....	<b>Recommended and Related Accessories</b>
P. 26.....	<b>Technical Support : Ikelite Limited Warranty</b>
P. 27.....	Returning Products for Service
P. 28.....	Ikelite Address & Website

**Congratulations** on your Ikelite purchase. Our products are designed and built in the USA by Ikelite for both the professional and amateur. Ikelite has decades of experience in the underwater photographic, video, and lighting market. The clear housing permits instant visual inspection of the camera and all sealing surfaces as well as complete monitoring of controls and camera LCD screens. This housing has been factory water pressure tested to 200' (60m). All camera controls are fully functional through the housing.

## Package Contents

- Ikelite Digital Housing
- Silicone Lubricant
- Vinyl Port Cover
- Diffuser
- Deflector
- Extra Control Tips

## Preparation

Please read this instruction booklet thoroughly before use to have a full understanding of where each camera control is located, and what function each control provides. Also, please read your camera manual thoroughly to fully understand each camera function. If you are new to underwater photography, be sure to read the Photo Tips section.

Before placing your camera in the housing, it is a good idea to immerse the closed housing in a bucket or rinse tank to make sure it is watertight.

Due to the power required to operate the camera and LCD screen, start each dive with a fully charged camera battery.

## Initial Camera Setup

1. Set ISO to 80.
2. Set camera mode dial to “Av” Aperture priority. In Aperture Priority mode “Av” the shutter speed should automatically go to 1/60 second.
3. Set Flash to “On” (lightning bolt in LCD).
4. For General photography, set aperture to f3.5.
5. For Macro photography, set aperture to f8.0.
6. Set White Balance (AWB) to “Auto.”
7. Set Image Size to “L” and compression to “S” Superfine.
8. Set Metering to “Center-Weighted Average.”
9. In the camera menu set the “ND” Filter to “Cancel.”

### NOTES:

TTL Flash is NOT available when camera is in “M” Manual mode. There is no TTL flash even with Canon's own flash in the camera "M" mode. Manual power settings can be selected with the multi-control button on the back of the camera. The strobe should still be left in TTL to take advantage of this feature.

Leave the housing hotshoe disconnected when using an EV manual controller. If using an EV controller in “M” Manual mode, set the EV controller to “non-Pre-flash.”

When multiple exposure (continuous shooting) mode is used, the external flash will not fire. This is normal and also happens with Canon external speedlights.

## Housing Controls - Front View

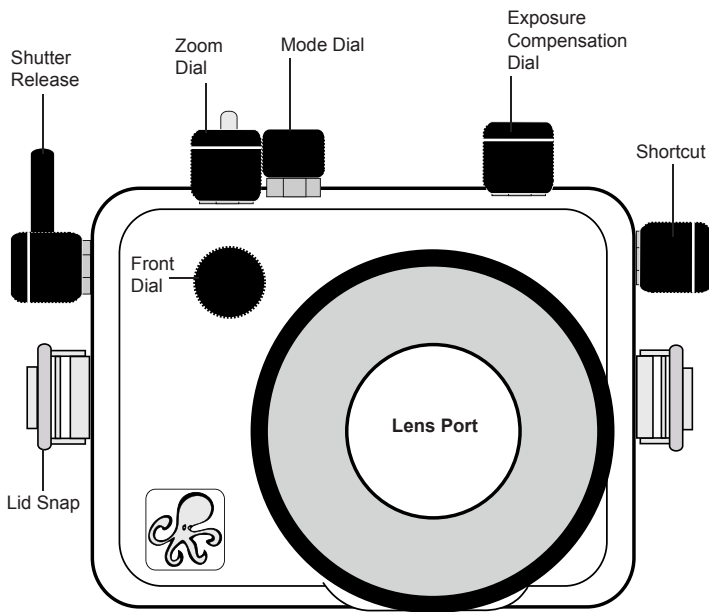

### Housing Front Dial Control

The Housing Front Dial Control rotates the G12 front dial. This control is NOT applicable to a G11 camera and will sit idle.

## Housing Controls - Back View

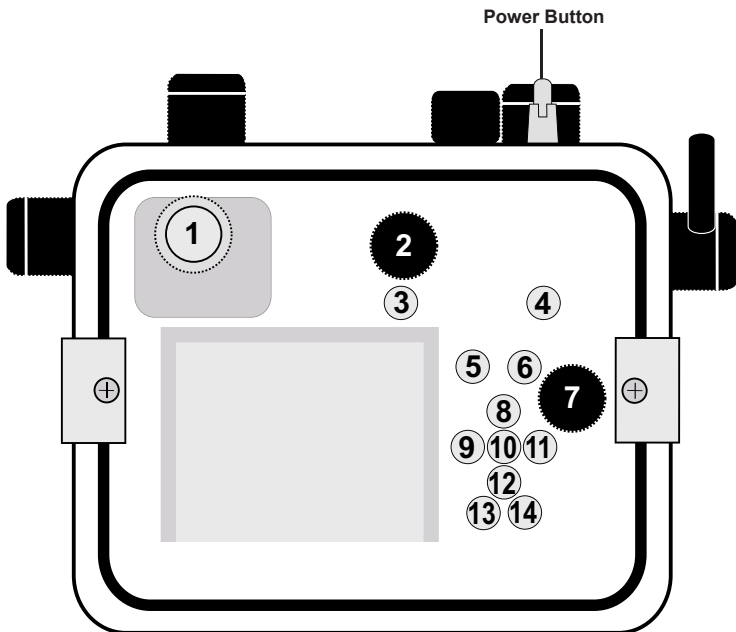

### Housing Controls

1. TTL Connector
2. ISO Dial
3. Playback
4. AE/FE Lock
5. Single Erase
6. Metering Light
7. Control Dial
8. Manual Focus
9. Macro
10. FUNC./SET
11. Flash
12. Self-Timer
13. Display
14. Menu

## Opening the Housing

Lid Snaps have a **Lock**.

To open housing, push Lid Snap Lock forward and lift as shown.

Keep pressure on the Lid Snap so it does not fly open quickly.

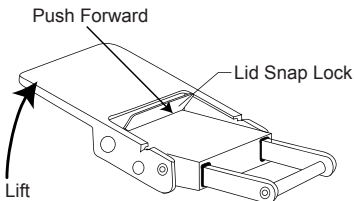

*Some lid snaps have a lot of spring tension once they go over center, so keep a firm grip on the lid snap. Lid Snaps may be opened one at a time.*

## Installing the Camera

1. Pull out on each housing control until it stops. This will get the controls out of the way for installation of the camera.
2. Remove the back from the housing.
3. The mounting tray for the camera is secured to the housing back. Position the camera on the tray.
4. Slide the housing Hotshoe Connector into the Camera Hothoe Mount - page 8, diagram A. Slide the connector forward until it stops. This should be done before the camera is secured with the mounting bolt - page 8, diagram B.

**Note:** If you are using an EV Controller and NOT hard-wiring your strobes directly to the housing, leave the housing hotshoe disconnected from the camera. You will also need to install the Flash Deflector (supplied) over the back of the housing port to block and deflect the camera flash to the EV controller.

### Caution:

Do not remove the External Strobe Connector Waterproof Cap - page 8, diagram A, unless an external sync cord is going to be plugged in. Do not remove the Waterproof Cap or Sync Cord underwater.

## Installing the Camera - continued

Diagram A

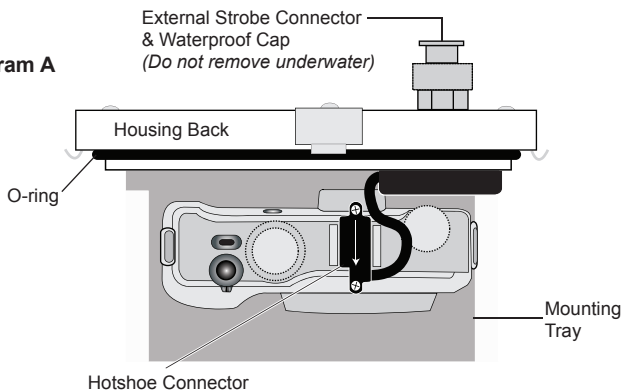
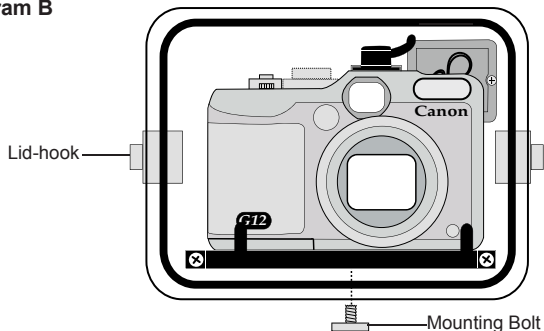

Diagram B



### CAUTION:

*Some camera tripod socket threads are plastic. The mounting bolt is metal. Do not cross thread or over tighten as you may damage the camera tripod socket threads.*

## Closing the Housing

1. Place housing face down in your lap or on flat surface.
2. Check to see that there is an o-ring on the housing back and that it is clean and in its proper location.
3. Guide the back into the housing front. The o-ring should touch the housing all the way around. There should be an even gap all the way around between the housing and the housing back.
4. Lift the lid snaps so they are extended and place each lid snap into the corresponding hook on the housing back.
5. To close the housing, push down on the lid snaps until they snap into place. Lid snaps on opposite sides of the housing should be closed at the same time. Be sure they are down far enough to engage the lock.

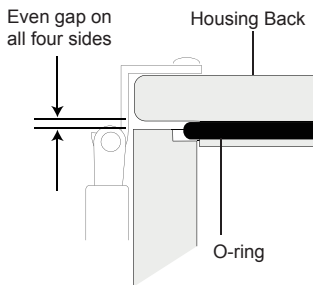
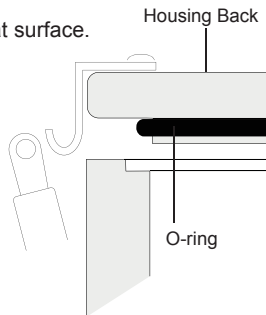

**Double check** - Once the housing is closed, check the o-ring seal. Check the gap between the housing back and the housing. It should be even all the way around the housing.

Look through the clear plastic back at the o-ring. You should see a darkened area where the o-ring is compressed against the housing back. If you do not see an even black compression seal all the way around the back, open the lid snaps, reset the housing back and close the lid snaps. Visually check the seal again.

## Usage

### Turn Camera On

Turn the camera on and operate each of the housing controls to get a feel for using the camera in the housing.

**You are now ready to shoot underwater photos!**

### Zoom Control (lever type only)

After you have used the housing's zoom control, it must be returned to the center position to disengage. If the housing zoom control is pushing the zoom lever in either direction, you may not be able to take a picture or access other functions. This is because the camera is receiving a signal from the engaged zoom control.



Zoom Control  
"Disengaged"  
(Center Position)



Zoom Control  
"Engaged"

### Using the Camera's Built-in Flash

If you are shooting with the camera's built-in flash and the camera's lens is set to the widest angle, you may need to zoom the lens slightly or a dark area may appear in a lower corner of close-up photographs. The lens port may block some of the light. Install the Diffuser and zoom in slightly to eliminate any dark areas noted in your photographs (*You can test this above water*). See Diffuser/Deflector Installation - page 11.

For the best results, we recommend using an external Ikelite Substrobe.

The camera's built-in flash CANNOT be used with optional Wide-Angle or Accessory lenses.

**Note:** To shoot photographs closer than 2 feet (0.6m), we recommend using an external strobe such as the DS51 or DS161. An external strobe can be positioned so nothing blocks the light path between the strobe and the subject. See Recommended and Related Accessories pages 19-25.

## Diffuser and Deflector Installation

A diffuser and deflector are included with the housing. The diffuser is white transparent plastic. The deflector is also white but is not transparent.

To install the diffuser or deflector, push the “Cut-out” Section into the port groove until it stops.

Note the Small Hole. To avoid losing the diffuser or deflector, you can attach a fishing line or string that is secured around the back of the housing port, to this hole.

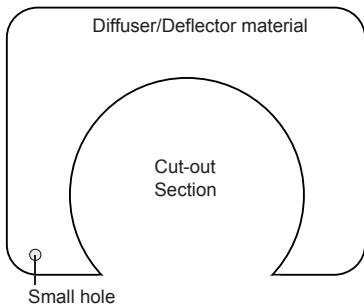

Diffuser/Deflector properly installed in port groove

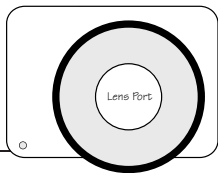

## Diffuser Use

The diffuser should be installed when using the camera flash. When shooting close-up photographs with the camera flash and at the camera lens's widest angle setting, the lens port on the housing can block a portion of the light from the camera flash. This can result in a shadow in a lower corner of the frame. Zoom the lens to eliminate the shadow (*You can test this above water*).

## Deflector Use

The deflector should be installed when using an Ikelite external strobe. The deflector will block and redirect the camera's flash to the EV-controller which controls the external strobe's output. Remove the diffuser before attempting to install the deflector.

## Entering the Water

1. As soon as you enter the water, take a moment and check the housing to see that it is properly sealed.
2. Next, check to see if there are any bubbles on the face of the lens port. If there are, take your finger and remove them. If there are bubbles on the lens port they can produce soft focus spots in your photos or video.

Treat the glass or acrylic in the lens port as a camera lens. After use, rinse and gently dry the lens port to avoid water spotting. To clean, use a mild soap solution or lens cleaner.

*Do not use alcohol or window cleaner on the Lens Port.*

## Maintenance

### Lubricant

- Ikelite provides silicone lubricant with the housing. We recommend you use only Ikelite lubricant on Ikelite products. Other brands may cause the main housing o-ring to swell and not seal properly.
- Use only enough lubricant to lightly cover the main housing o-ring or lubricate a sticky control. Wipe off any excess lubricant with a clean cloth. Lubricant is not a sealant, it is used to reduce friction. Excessive lubricant can collect sand and dirt which may interfere with proper sealing.

### CAUTION:

**Never use spray lubricants as the propellant ingredient can cause the plastic housing to crack or o-rings to swell.**

## Housing Maintenance

The Ikelite Digital Housing should be given the same care and attention as your other photographic equipment. In addition to normal maintenance, we recommend that the housing be returned to Ikelite periodically to be checked and pressure tested.

1. **Do Not** leave the camera and housing in direct sunlight for prolonged periods. Heat may damage the camera.
2. **Do Not** ship the camera in the housing.
3. Before using the housing, always check the tightness of the **set screw** in each control knob.

Check each **control gland** penetrating the housing to make sure they are tight. There is a slight chance that either could vibrate loose during travel.

4. Keep the main housing o-ring clean and lightly lubricated. To lubricate, remove the o-ring from the back. Put a small amount of Ikelite lubricant on your fingers. Pull the o-ring through your fingers to apply a **light** coating of lubricant. Only apply enough lubricant to make the o-ring feel slick. **Do Not stretch the o-ring**. This light coating of lubricant will help to keep the o-ring from drying out and will help to show a dark sealing line when the housing back is properly sealed.
5. Keep the area where the o-ring fits and the sealing surface of the housing clean.
6. Rinse the housing exterior thoroughly in freshwater after each saltwater use. Dry with a soft cloth. Dry lens port to eliminate water spotting. After several uses in saltwater, soak the housing exterior in a mild soap solution, rinse and dry before storing. When storing the housing, remove the back o-ring, lightly lubricate, and place in a plastic bag. Place the plastic bag with o-ring inside the housing for safe keeping.
7. If removing a housing push button, **Do Not** re-use the E-clip. Contact Ikelite for replacement E-clips (part #0319.12).
8. Leave lid snaps in the open position when not using the housing for extended periods.

## Control Maintenance

Ikelite controls are designed to provide years of reliable service with minimal maintenance.

1. Push button controls normally require no maintenance other than rinsing in fresh water after saltwater use. If a push button control becomes difficult to push or if it sticks when depressed, soak the housing in luke warm freshwater. After a few minutes, operate the push button. If this does not correct the problem, return the housing to Ikelite for maintenance. If you are on a trip and unable to return the housing immediately, a push button may be lubricated by pressing and holding the push button all the way in. Then, use your finger or other small object to place a small amount of lube at the base of the shaft inside the housing. Press and release the push button several times until the lube is worked up into the o-ring.
2. Some of the controls have long shafts. These controls can be pulled out, exposing the shaft see diagrams B and C - page 15. To lubricate the control, gently pull on the knob until the stainless steel shaft is exposed. Lightly lubricate the shaft, then move the shaft in and out several times. This will lubricate the x-ring in the Ikelite control gland. This should be done before using the housing after a prolonged storage period, or once a week when the housing is in constant use.
3. Some of the controls have a short shaft and cannot be pulled out exposing the shaft for lubrication. In the unlikely event one of these controls sticks or becomes difficult to operate, you can remove the control from the housing and lubricate it, or return the housing to Ikelite for maintenance. To remove the control, diagram B - page 15, loosen the set screw in the knob (allen wrench required); remove the knob. If there is salt or dirt build-up on the exposed control shaft, clean the shaft. Open the housing and gently slide the control shaft out of the control gland. Clean and lightly lubricate the shaft, including the end of the shaft.

## Control Maintenance - continued

Slide the shaft back into the control gland and gently slide it back and forth a few times without fully removing the shaft from the gland. Replace the knob noting the flat area on the shaft. The set screw in the knob should tighten down against the flat area on the control so the knob does not turn on the shaft.

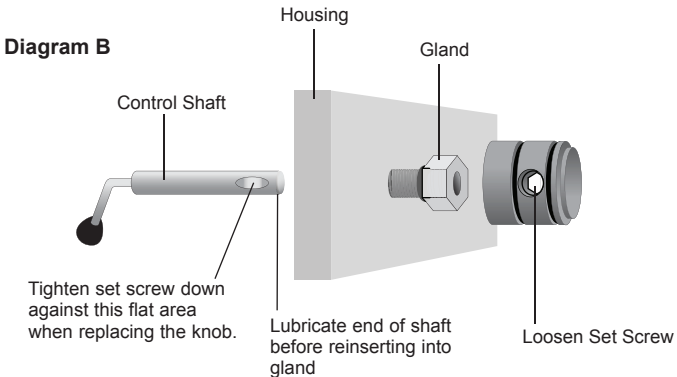

### Diagram C

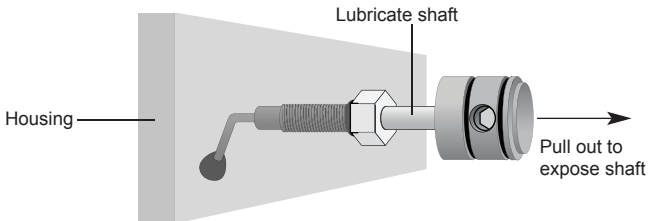

## Specifications

7 in. wide x 5 in. high x 5.4 in. deep including controls and lens port.

180mm x 130mm x 140mm.

2.8 lb. (1300g) above water.

Slightly negative buoyancy in fresh water.

## Photo Tips

1. The number one rule in underwater photography is to eliminate as much water between the camera and subject as possible. Get as close as you can to the subject, then use the zoom. If you are using flash for still photos, subjects beyond 6 feet (1.8m) will not have much color regardless of strobe power.
2. The camera's built-in flash is very close to the camera lens. The flash can light up any suspended particles in the water and they can be recorded in your picture. This effect is called backscatter. To eliminate as much backscatter as possible, photograph close or use an external strobe. Photograph in clear water; do not stir up the sand or silty bottom. If backscatter becomes a problem in the environment you are photographing, an external flash will help eliminate much of the backscatter.
3. Many digital cameras have a slight lag time between when you press the shutter release button and the camera actually takes the picture. Hold the camera steady a second or two after pressing the shutter release button.
4. Do not shoot down on subjects as they will quite often blend into the background and be difficult to see in the photograph. Shoot subjects straight on or shoot up at a slight angle using the blue water as a contrasting background.

## Photo Tips - continued

5. Underwater flash is used to restore the warmer colors filtered out by the water as well as to illuminate the subject. When photographing underwater, set the camera to use flash on every shot. If the camera's flash is set to AUTO and the sun is behind your subject, the camera may see enough light and not fire the flash. With the sun behind the subject, the subject is shaded (dark) and needs flash for a good exposure.
6. When using daylight or flash, if your camera consistently over or underexposes the image, you may want to adjust your camera's exposure compensation settings. Also, set the camera metering to "center-weighted" or "spot."
7. Many photographers transfer their images to the computer where they can fine tune the appearance of the image. Many of the image manipulation programs make you think you can magically correct any image taken and make a good picture. Remember that when using an image manipulation program such as Photoshop, that if the image is overexposed, much of the color is missing. If the color is missing you cannot adjust it. If images are slightly underexposed, the color is there, but it is just dark and you can adjust it to some degree. So, if you error in exposure, it is better to have the image slightly underexposed rather than overexposed.

# Troubleshooting

<b>Problem</b>	<b>Solution</b>
Push buttons or controls are sticky and hard to operate	<ul style="list-style-type: none"><li>- Remove the camera and rinse the closed housing in fresh water. Vigorously press each push button in and out several times to release any trapped saltwater or debris.</li><li>- Press a sticky push button all the way in and place a small amount of lube on the small end of the push button shaft at it's base. Release and operate the push button several times to distribute the lube.</li><li>- If a control is sticky, grab the control knob, pull it out, and then push back in. If still sticky, see the Control Maintenance section - pages 14 &amp; 15.</li><li>- Return housing to Ikelite for routine maintenance.</li></ul>
<b>Problem</b>	<b>Solution</b>
Image is over- or under-exposed, or a corner of the image is dark	<ul style="list-style-type: none"><li>- Check that the camera flash is firing when taking a picture. Camera flash should be forced "on."</li><li>- Make sure the deflector is installed when you are using an external strobe.</li><li>- Make sure the diffuser is installed when you are NOT using an external strobe.</li><li>- When using an external strobe, make sure it is turned on, set properly, and it's battery is charged.</li><li>- Check all corded connection points.</li><li>- Change camera shutter speed or aperture.</li><li>- Move closer to or further away from the subject.</li></ul>

<b>Problem</b>	<b>Solution</b>
Camera does not take a picture	<ul style="list-style-type: none"> <li>- Install a fully charged battery.</li> <li>- Make sure the housing zoom control is centered and not engaged.</li> <li>- There is not enough available light for the camera to properly focus. Add a focusing light or strobe with a built-in focusing light to your system.</li> <li>- Select macro mode when shooting close-ups.</li> </ul>
<b>Problem</b>	<b>Solution</b>
Housing is hard to close	<ul style="list-style-type: none"> <li>- Make sure the camera is mounted properly on the camera tray and housing controls are out of the way .</li> </ul>
<b>Problem</b>	<b>Solution</b>
Fogging occurs on the Lens Port	<ul style="list-style-type: none"> <li>- Humid air is trapped inside the housing. The camera produces heat and may condense any trapped moisture forming fog on the lens port. Close the housing in an air-conditioned room or vehicle, or in front of an air-conditioner.</li> <li>- The housing should not be direct sunlight for an extended period of time.</li> <li>- Purchase desiccant packs also known as moisture munchers from a local camera store. Place one or two packs in your housing before each day of diving.</li> <li>- If water droplets or moisture is present around the controls or sealing areas, return the housing to Ikelite for evaluation.</li> <li>- Clean the main housing o-ring and sealing surface of the housing.</li> </ul>

## Recommended and Related Accessories

### External UR-Pro Color Filters

Color filters such as the UR-Pro Filter replace some of the reds, oranges and more natural tones that would otherwise be lost underwater. Effective in relatively shallow, sunny conditions. Available for tropical blue water and green water settings. For optimum results use in combination with manual white balance. Check your camera user guide for information on this option (if available). Not recommended when using external strobes.

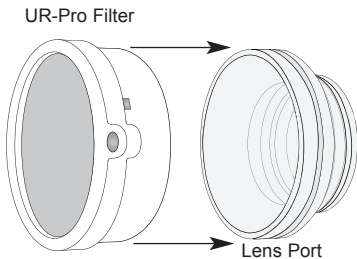

### UR/Pro Filter (Blue Water)

#### 6441.46 (3.9" port)

The UR/Pro underwater color correcting filter is designed to restore some of the warm colors filtered out by the water. For available light use only. Not recommended for use with an external flash.

### UR/Pro Filter (Green Water)

#### 6441.86 (3.9" port)

Enhances contrast and alters the color of green water to give your subject a rich, natural tone. For available light use only. Not recommended for use with an external flash.

## Pro-V8 LED Video Lite 6320

For additional lighting when using the camera's movie mode and to aid in focus.

For use with or without a color filter.

For more information go to the following web page:

[http://www.ikelite.com/web\\_pages/3prov8.html](http://www.ikelite.com/web_pages/3prov8.html)

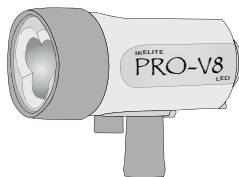

Pro-V8 LED Video Lite 6320

## DS51 Substrobe

The DS51 Substrobe covers the equivalent of a 28mm lens. It is the ideal choice when using only the camera lens with no accessory wide angle lenses attached.



Substrobe  
DS51

Actual Size:  
8 cm diam. x 12 cm  
3.2" diam. x 4.7"

## DS161 Movie Substrobe

The DS161 Movie Substrobe combines all of the functionality of our renowned DS160 Strobe with a powerful 500 lumen LED video light. Three super-bright LEDs are arranged behind a special optical element to provide a 45 degree angle of coverage, free of hotspots.

## DS161 - continued

The DS161 flash covers the equivalent of an 18mm lens or 100 degrees w/diffuser installed. It is the ideal choice when using wide angle lenses greater than 80 degrees. It also features a 1.5 second recycle time and 225 flashes per full charge.

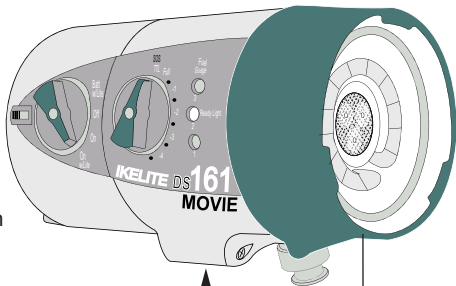

## SA-100 Ball/Socket Arm

The SA-100 system 4086.61 with its 1" diameter ball is ideal underwater. The 9571.3 extended stem mount allows easy attachment of the EV controller or flashlight mount, and drops right into the release handle. The arm system allows easy strobe placement from macro close-up to wide angle. The complete system removes with a push of the handle button.

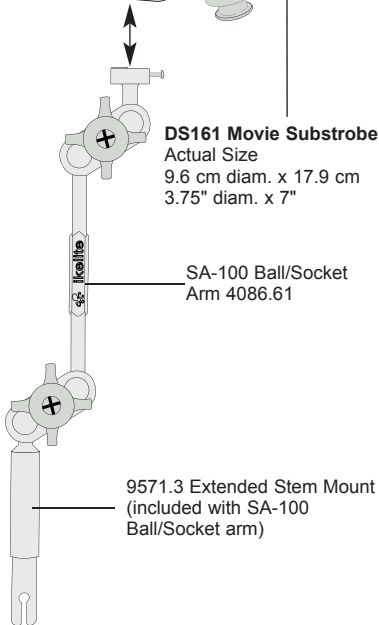

**DS161 Movie Substrobe**  
Actual Size  
9.6 cm diam. x 17.9 cm  
3.75" diam. x 7"

SA-100 Ball/Socket  
Arm 4086.61

9571.3 Extended Stem Mount  
(included with SA-100  
Ball/Socket arm)

**Substrobe DS-51 Package 3944.54** includes 4086.61 Arm System with EV Manual Controller.

**Substrobe DS-160 Package 3944.91** includes 4086.61 Arm System and 1.5 hour Smart Charger with EV Manual Controller.

**Substrobe DS-161 Package 3945.03** includes 4086.61 Arm System and 1.5 hour Smart Charger with EV Manual Controller.

Optional 9523.62 dual tray and handles are required for the attachment of two DS-series strobes. The optional 9571.3 - Page 22 features a 1" (2.5cm) ball for attachment to the top of the release handle. This provides a mounting point for Ultralight, TLC, and other non-Ikelite arm systems.

### **Please Read If Using an EV Manual Controller**

The EV-Controller used with Ikelite DS Substrobes has two user settings. One setting is for strobe selection, the other is for pre-flash "P" or non pre-flash "P." Most cameras use a pre-flash. This means the EV-Controller should be set to the pre-flash "P" position when used with this camera as a slave. If a manual mode is used that does not emit a pre-flash, set the EV-controller to the non pre-flash "P" position.

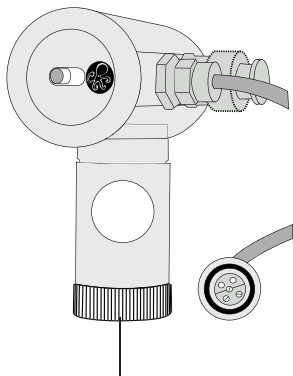

Ikelite EV Manual Controller

## Recommended and Related Accessories - continued

### Main Housing O-ring 0110

### Lanyard 0321.10

### Vinyl Port Cover 0200.08

### Ikelite Lube 5020 (4 - 1cc tubes)

For light lubrication of the main housing o-ring.

### Travel Case 3920

This optional carrying case with foam will accommodate the housing with a DS51 strobe, and a single tray with handle and accessories.

### Tray with Single Release Handle 9523.61

*(Included with Housing)*

Single Tray with Release Handle offers more control and stability underwater, and is required to mount one external DS-series Substrobe.

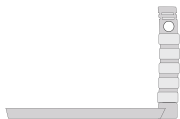

Single Tray/Handle 9523.61

### Tray with Dual Release Handles 9523.62

Dual Tray with Release Handles offer more control and stability underwater, and is required to mount two external DS-series Substrobes.

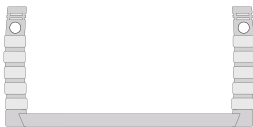

Dual Tray/Handle 9523.62

## Recommended Accessory Lenses

### WD-4 Wide-Angle Conversion Dome 6430.4

The removeable WD-4 corrects light refraction underwater, restoring the camera's original angle of coverage. Approximately 3/4 of the camera's zoom range can be used with the dome in place. Slight vignetting may occur at camera's widest angle setting.

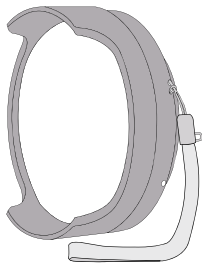

### External Macro Adaptor 9306.82

Allows attachment of 67mm threaded macro lenses from Inon and Epoque. NOT for use with 67mm threaded wide-angle lenses.

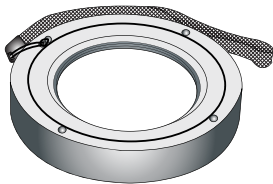

**NOTE:** Other Accessory and Wide-Angle Conversion lenses cannot be used with this housing. For additional information regarding recommended strobe packages and optional accessories, go to [www.ikelite.com](http://www.ikelite.com).

## Technical Support

### **Ikelite Technical Support**

E-mail: [ikelite@ikelite.com](mailto:ikelite@ikelite.com)

Phone 317.923.4523

Fax 317.924.7988

### **Ikelite Limited Warranty**

All Ikelite products are warranted against any manufacturing defects for a period of one year from the original date of purchase. Defective products should be returned prepaid to Ikelite. Ikelite will, at its discretion, repair or replace such products, and will return to customer prepaid. All other claims of any nature are not covered. Housing is pressure tested and warranted to 200' (60m) maximum underwater depth. Except as mentioned above, no other warranty expressed or implied, applies to this Ikelite product.

## **Returning Products for Service**

Ikelite is most interested in performing any service to ensure that all products perform as intended. Evidence of purchase date must be provided to obtain warranty service.

No prior authorization is required. You may return directly to us or through your dealer. Please include a brief description of the problem, any relevant e-mail correspondence, and/or instructions on what you want us to do. Always include name, shipping address, e-mail address, and phone number inside of the package.

You may also want to insure the package.

Send Postage Pre-Paid to:

Ikelite Underwater Systems  
ATTN: Repair Dept.  
50 West 33 Street  
Indianapolis, IN 46208 USA

No reimbursements for return freight will be issued.

## **Returning Products for Service (outside the United States)**

For the separate international customs documentation form that you complete to accompany the shipment, please state or designate that the enclosed products were originally manufactured in the USA and are being returned to the manufacturer for repair service. Value of the equipment listed for customs purposes should be zero.



**Ikelite Underwater Systems  
50 West 33rd Street  
Indianapolis, IN 46208 USA**

**[www.ikelite.com](http://www.ikelite.com)**